

Natural choice for your home



unfinished hardwood  
**DECKING 2011**

*Classic Collection*





*Respect for the environment  
by using forest handling.*

## what you need to know

natural wood variations

Solid wooden flooring is a natural material that will add value to your house. However, wood has particularities that should be taken into account:

The solid flooring is natural and there can be differences in coloration among pieces. One tree is not identical to another; that is what makes of solid wooden flooring a unique piece. Brasil Tropical Pisos cannot be hold accountable for color variations and granulation found in a flooring lot. Talk to your supplier for him to introduce you to variations available.

Wood is similar to human skin; its natural color can change when it is under sunlight. Some species can become darker than others.

Wood can expand or contract according to exposed moisture levels. This not a manufacture defect, but a reaction that can be abated by using finishes that will reduce the action of moisture over the flooring.

## technical especifications



Brasil Tropical Pisos offers you a catalog with all necessary technical specifications for you to choose the most appropriate product for you customer portfolio. The sales department should be consulted first for orders of specific products. You can make downloads from our site.



## packaging



Our products are carefully packed after production. The entire process is reviewed by quality control and the strictest procedure regulations are followed. Brasil Tropical Pisos cannot be hold accountable for bad package handling during unload.

## Sales



Brasil Tropical Pisos does not perform direct sales to final consumers, but our sales department is ready to advice you when searching for the nearest dealer or distributor. Call our sales department.

espécies de madeira



**Garapeira** (*Apuleia sp*)



**Ipê** (*Tabebuia sp*)



**Tatajuba** (*Bagassa guianensis*)



**Maçaranduba** (*Manilkara sp*)



**Cumaru** (*Dipteryx sp*)



**Sucupira preta** (*Bowdichia sp*)



[www.brasiltropicalpisos.com](http://www.brasiltropicalpisos.com)

Fone/Fax: 55 66 3512 2000 • [sales@brasiltropicalpisos.com](mailto:sales@brasiltropicalpisos.com)

unfinished hardwood  
**DECKING 2011**

*Classic Collection*



## USINAGEM LATERAL (A/B)

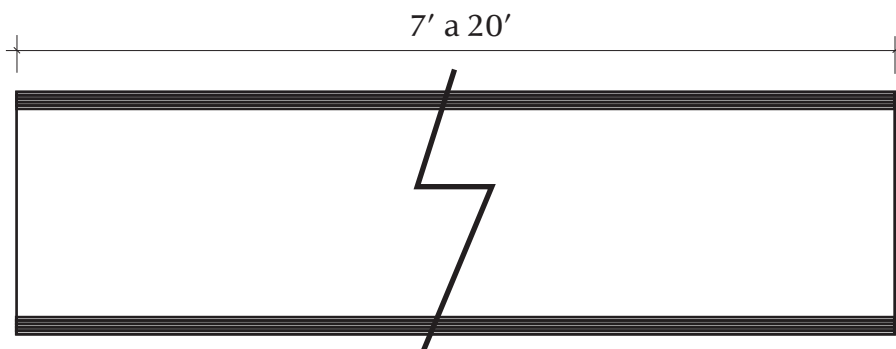

## USINAGEM TOPO (C/D)

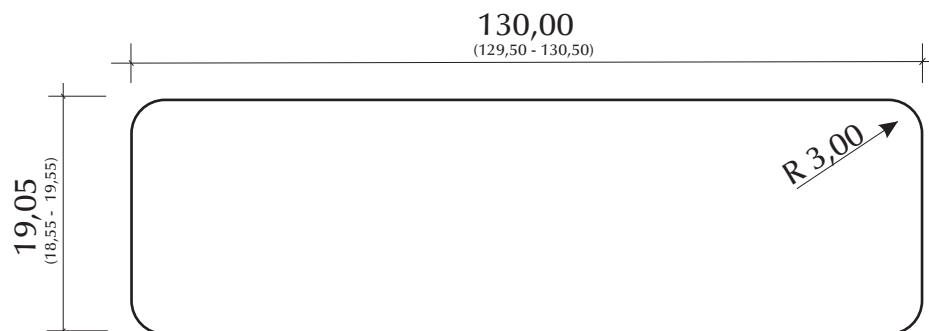

### CDT - CONTROLE DE DOCUMENTOS TÉCNICOS

Produto: Deck Classic 1- Israel - 130,0 x 19,05mm

Cód. Produto: dck\_cls\_130\_1905

Arquivo Digital: dt\_eng\_dck\_cls\_130\_1905\_v\_2010\_01

Versão: dck\_cls\_130\_1905\_v\_2010\_01

Catálogo: tec\_deck\_clasic\_eng\_2010.pdf

### Dimensional Reading / mm

55,80 → Nominal dimension  
(55,00 - 56,60) → Tolerance

· Drawings are scaleless / All measurements are in millimeters  
· Dimensions may change according to internal quality procedures.

### Viewer

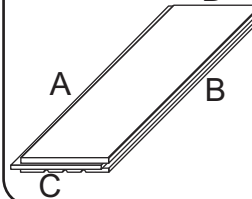

Certificado  
NBR ISO 9001



**Product:** Deck Classic - 1- Israel - 130,0 x 19,05mm  
**Code:** dt\_pt\_dck\_cls\_130\_1905\_v\_2010\_01  
**Thickness:** 19,05mm  
**Width:** 130,00mm  
**Length:** 7' a 20'  
**Variation:** 3', 4', 5', 6'  
**Version:** dck\_cls\_130\_1905\_v\_2010\_01

### ·Product available in the following types

- *Cumaru (Dipteryx sp)*
- *Garapeira (Apuleia sp)*
- *Ipê (Tabebuia sp)*
- *Tatajuba (Bagassa guianensis)*
- *Sucupira preta (Bowdichia sp)*
- *Maçaranduba (Manilkara sp)*

### ·Shipment Composition: Container DRY - 20"

- *Cumaru (Dipteryx sp)*- 22,00m<sup>3</sup>
- *Ipê (Tabebuia sp)*- 20,00m<sup>3</sup>

### Drying:

KD> Dry in a 16-16 % drying stove

### Weight / KD

- *Cumaru (Dipteryx sp)*- 1.250Kg/m<sup>3</sup> [ (+10%) ou (-10%) ]
- *Ipê (Tabebuia sp)* - 1.300Kg/m<sup>3</sup> [ (+10%) ou (-10%) ]

### Milling

· Decking suitable for external use with grooved finish cut on the top and bottom side, and with smooth finish and four round corners of a 3.00-mm radius. S4S e E4E.

### Pallet Stacking

Steel taped. Stacks of specific length and width. Stacked with separators and waxed on top

## USINAGEM LATERAL (A/B)

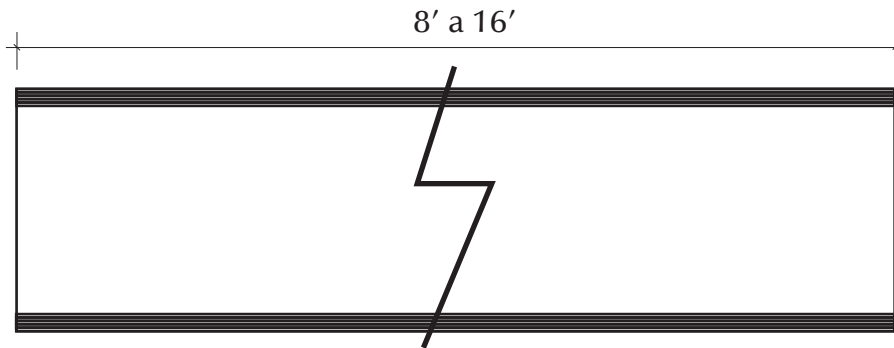

## USINAGEM TOPO (C/D)

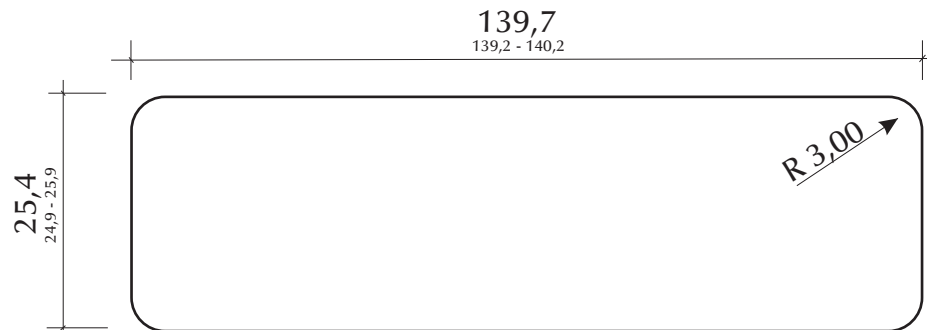

### CDT - CONTROLE DE DOCUMENTOS TÉCNICOS

Produto: Deck Classic 2- Israel - 139,7 x 25,4mm

Cód. Produto: dck\_cls\_13970\_2540

Arquivo Digital: dt\_eng\_dck\_cls\_13970\_2540\_v\_2010\_01

Versão: dck\_cls\_13970\_2540\_v\_2010\_01

Catálogo: tec\_deck\_clasic\_eng\_2010.pdf

### Dimensional Reading / mm

55,80 → Nominal dimension  
(55,00 - 56,60) → Tolerance

· Drawings are scaleless / All measurements are in millimeters  
· Dimensions may change according to internal quality procedures.

### Viewer

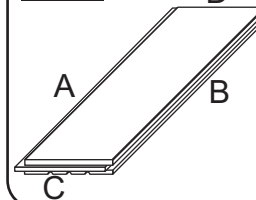

**Product:** Deck Classic 2- Israel - 139,7 x 25,4mm

**Code:** dck\_cls\_13970\_2540

**Thickness:** 25,4mm

**Width:** 139,7mm

**Length:** 8' a 16'

**Variation:** 3',4',5',6'

**Version:** dck\_cls\_13970\_2540\_v\_2010\_01

### ·Product available in the following types

- *Cumaru* (*Dipteryx sp*)
- *Garapeira* (*Apuleia sp*)
- *Ipê* (*Tabebuia sp*)
- *Tatajuba* (*Bagassa guianensis*)
- *Sucupira preta* (*Bowdichia sp*)
- *Maçaranduba* (*Manilkara sp*)

### ·Shipment Composition: Container DRY - 20"

- *Cumaru* (*Dipteryx sp*)- 22,00m<sup>3</sup>
- *Ipê* (*Tabebuia sp*)- 20,00m<sup>3</sup>

### Drying:

KD> Dry in a 16-16 % drying stove

### Weight / KD

- *Cumaru* (*Dipteryx sp*)- 1.250Kg/m<sup>3</sup> [ (+10%) ou (-10%)]
- *Ipê* (*Tabebuia sp*) - 1.300Kg/m<sup>3</sup> [ (+10%) ou (-10%)]

### Milling

· Decking suitable for external use with grooved finish cut on the top and bottom side, and with smooth finish and four round corners of a 3.00-mm radius. S4S e E4E.

### Pallet Stacking

Steel taped. Stacks of specific length and width. Stacked with separators and waxed on top

## USINAGEM LATERAL (A/B)

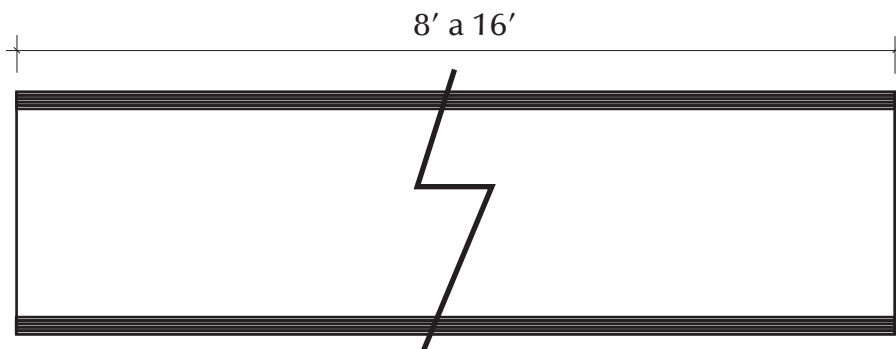

## USINAGEM TOPO (C/D)

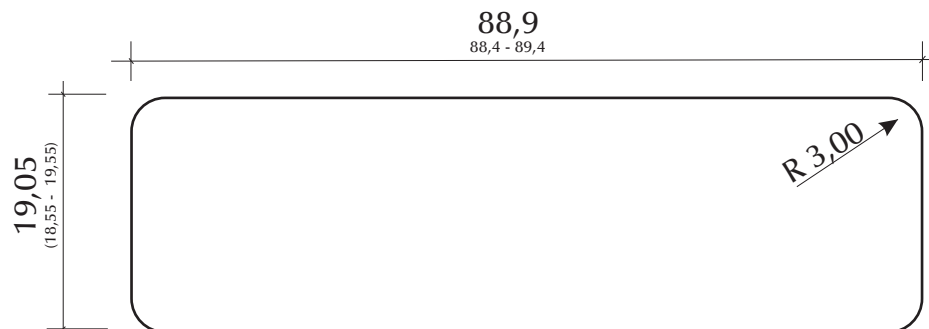

### CDT - CONTROLE DE DOCUMENTOS TÉCNICOS

Produto: Deck Classic 3- USA - 88,90 x 19,05mm

Cód. Produto: dck\_cls\_8890\_1905

Arquivo Digital: dt\_eng\_dck\_cls\_8890\_1905\_v\_2010\_01

Versão: dck\_cls\_8890\_1905\_v\_2010\_01

Catálogo: tec\_deck\_clasic\_eng\_2010.pdf

### Dimensional Reading / mm

55,80 → Nominal dimension  
(55,00 - 56,60) → Tolerance

· Drawings are scaleless / All measurements are in millimeters  
· Dimensions may change according to internal quality procedures.

### Viewer

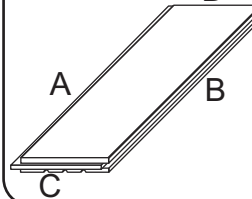

**Product:** Deck Classic 3- USA - 88,90 x 19,05mm

**Code:** dck\_cls\_8890\_1905

**Thickness:** 19,05mm

**Width:** 88,9mm

**Length:** 8' a 16'

**Variation:** 4',5',6',7'

**Version:** dck\_cls\_8890\_1905\_v\_2010\_01

### ·Product available in the following types

- **Cumaru** (*Dipteryx sp*)
- **Garapeira** (*Apuleia sp*)
- **Ipê** (*Tabebuia sp*)
- **Tatajuba** (*Bagassa guianensis*)
- **Sucupira preta** (*Bowdichia sp*)
- **Maçaranduba** (*Manilkara sp*)

### ·Shipment Composition: Container DRY - 20"

- **Cumaru** (*Dipteryx sp*)- 22,00m<sup>3</sup>
- **Ipê** (*Tabebuia sp*)- 20,00m<sup>3</sup>

### Drying:

KD> Dry in a 16-16 % drying stove

### Weight / KD

- **Cumaru** (*Dipteryx sp*)- 1.250Kg/m<sup>3</sup> [ (+10%) ou (-10%) ]
- **Ipê** (*Tabebuia sp*) - 1.300Kg/m<sup>3</sup> [ (+10%) ou (-10%) ]

### Milling

· Decking suitable for external use with grooved finish cut on the top and bottom side, and with smooth finish and four round corners of a 3.00-mm radius. S4S e E4E.

### Pallet Stacking

Steel taped. Stacks of specific length and width. Stacked with separators and waxed on top

## USINAGEM LATERAL (A/B)

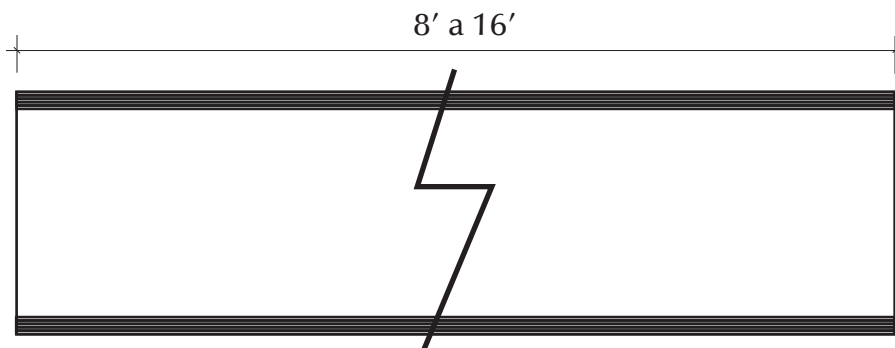

## USINAGEM TOPO (C/D)

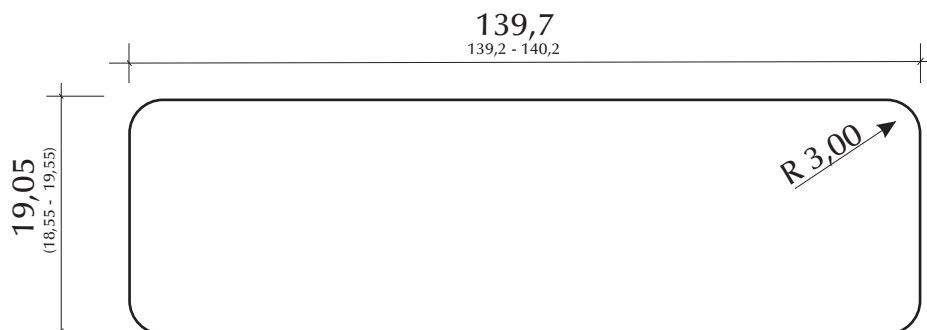

### CDT - CONTROLE DE DOCUMENTOS TÉCNICOS

Produto: Deck Classic 4- USA - 13970 x 19,05mm

Cód. Produto: dck\_cls\_13970\_1905

Arquivo Digital: dt\_eng\_dck\_cls\_13970\_1905\_v\_2010\_01

Versão: dck\_cls\_13970\_1905\_v\_2010\_01

Catálogo: tec\_deck\_clasic\_eng\_2010.pdf

### Dimensional Reading / mm

55,80 → Nominal dimension  
(55,00 - 56,60) → Tolerance

· Drawings are scaleless / All measurements are in millimeters  
· Dimensions may change according to internal quality procedures.

### Viewer

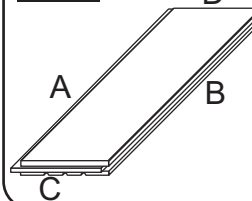

Certificado  
NBR ISO 9001



**Product:** Deck Classic 4- USA - 139,70 x 19,05mm

**Code:** dck\_cls\_13970\_1905

**Thickness:** 19,05mm

**Width:** 139,07mm

**Length:** 8' a 16'

**Variation:** 4',5',6',7'

**Version:** dck\_cls\_13970\_1905\_v\_2010\_01

### ·Product available in the following types

- **Cumaru** (*Dipteryx sp*)
- **Garapeira** (*Apuleia sp*)
- **Ipê** (*Tabebuia sp*)
- **Tatajuba** (*Bagassa guianensis*)
- **Sucupira preta** (*Bowdichia sp*)
- **Maçaranduba** (*Manilkara sp*)

### ·Shipment Composition: Container DRY - 20"

- **Cumaru** (*Dipteryx sp*)- 22,00m<sup>3</sup>
- **Ipê** (*Tabebuia sp*)- 20,00m<sup>3</sup>

### Drying:

KD> Dry in a 16-16 % drying stove

### Weight / KD

- **Cumaru** (*Dipteryx sp*)- 1.250Kg/m<sup>3</sup> [ (+10%) ou (-10%) ]
- **Ipê** (*Tabebuia sp*) - 1.300Kg/m<sup>3</sup> [ (+10%) ou (-10%) ]

### Milling

· Decking suitable for external use with grooved finish cut on the top and bottom side, and with smooth finish and four round corners of a 3.00-mm radius. S4S e E4E.

### Pallet Stacking

Steel taped. Stacks of specific length and width. Stacked with separators and waxed on top

## USINAGEM LATERAL (A/B)

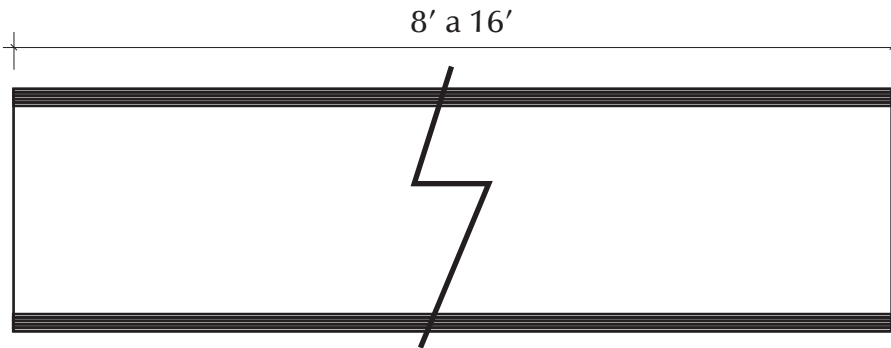

## USINAGEM TOPO (C/D)

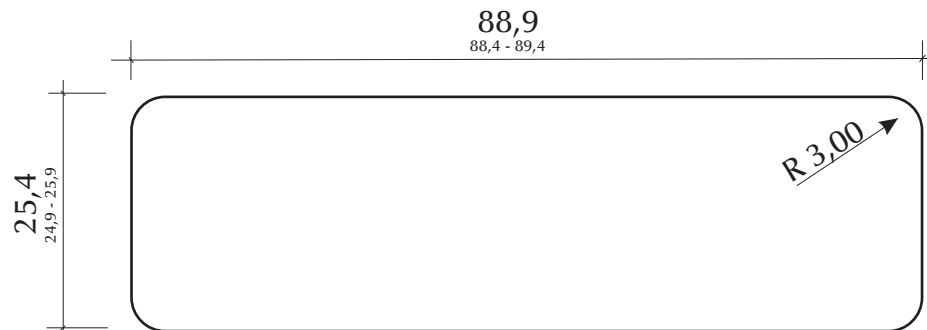

### CDT - CONTROLE DE DOCUMENTOS TÉCNICOS

Produto: Deck Classic 5- USA - 88,90 x 25,40mm

Cód. Produto: dck\_cls\_8890\_2540

Arquivo Digital: dt\_eng\_dck\_cls\_8890\_2540\_v\_2010\_01

Versão: dck\_cls\_8890\_2540\_v\_2010\_01

Catálogo: tec\_deck\_clasic\_eng\_2010.pdf

### Dimensional Reading / mm

55,80 → Nominal dimension  
(55,00 - 56,60) → Tolerance

· Drawings are scaleless / All measurements are in millimeters  
· Dimensions may change according to internal quality procedures.

### Viewer

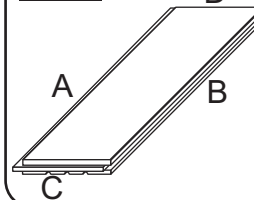

**Product:** Deck Classic 5- USA - 88,90 x 25,40mm  
**Code:** dck\_cls\_8890\_2540  
**Thickness:** 25,4mm  
**Width:** 88,9mm  
**Length:** 8' a 16'  
**Variation:** 4',5',6',7'  
**Version:** dck\_cls\_8890\_2540\_v\_2010\_01

### ·Product available in the following types

- *Cumaru* (*Dipteryx sp*)
- *Garapeira* (*Apuleia sp*)
- *Ipê* (*Tabebuia sp*)
- *Tatajuba* (*Bagassa guianensis*)
- *Sucupira preta* (*Bowdichia sp*)
- *Maçaranduba* (*Manilkara sp*)

### ·Shipment Composition: Container DRY - 20"

- *Cumaru* (*Dipteryx sp*) - 22,00m<sup>3</sup>
- *Ipê* (*Tabebuia sp*) - 20,00m<sup>3</sup>

### Drying:

KD> Dry in a 16-16 % drying stove

### Weight / KD

- *Cumaru* (*Dipteryx sp*) - 1.250Kg/m<sup>3</sup> [ (+10%) ou (-10%) ]
- *Ipê* (*Tabebuia sp*) - 1.300Kg/m<sup>3</sup> [ (+10%) ou (-10%) ]

### Milling

· Decking suitable for external use with grooved finish cut on the top and bottom side, and with smooth finish and four round corners of a 3.00-mm radius. S4S e E4E.

### Pallet Stacking

Steel taped. Stacks of specific length and width. Stacked with separators and waxed on top

## USINAGEM LATERAL (A/B)

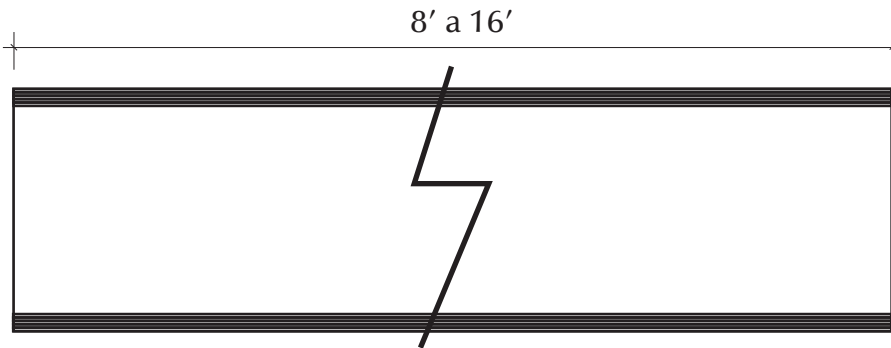

## USINAGEM TOPO (C/D)

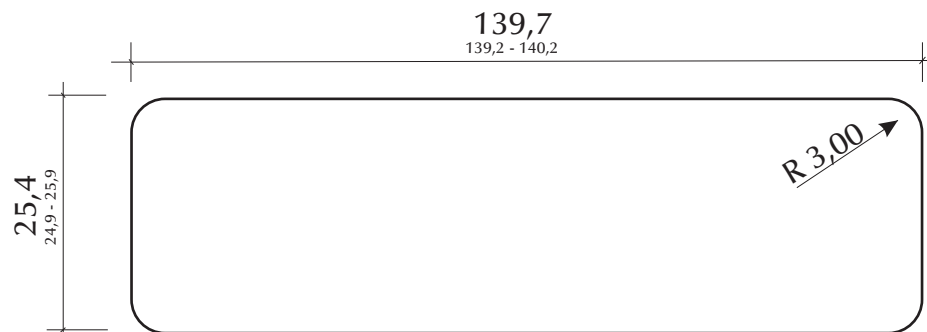

### CDT - CONTROLE DE DOCUMENTOS TÉCNICOS

Produto: Deck Classic 6- USA -139,7 x 25,40mm

Cód. Produto: dck\_cls\_13970A\_2540

Arquivo Digital: dt\_eng\_dck\_cls\_13970a\_2540\_v\_2010\_01

Versão: dck\_cls\_13970A\_2540\_v\_2010\_01

Catálogo: tec\_deck\_clasic\_pt\_2010.pdf

### Dimensional Reading / mm

55,80 → Nominal dimension  
(55,00 - 56,60) → Tolerance

· Drawings are scaleless / All measurements are in millimeters  
· Dimensions may change according to internal quality procedures.

### Viewer

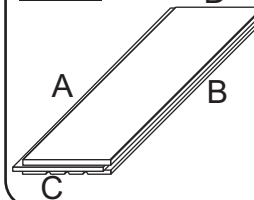

**Product:** Deck Classic 6- USA - 139,70 x 25,40mm

**Code:** dck\_cls\_13970A\_2540

**Thickness:** 25,4mm

**Width:** 139,7mm

**Length:** 8' a 16'

**Variation:** 4',5',6',7'

**Version:** dck\_cls\_13970A\_2540\_v\_2010\_01

### ·Product available in the following types

- **Cumaru** (*Dipteryx sp*)
- **Garapeira** (*Apuleia sp*)
- **Ipê** (*Tabebuia sp*)
- **Tatajuba** (*Bagassa guianensis*)
- **Sucupira preta** (*Bowdichia sp*)
- **Maçaranduba** (*Manilkara sp*)

### ·Shipment Composition: Container DRY - 20"

- **Cumaru** (*Dipteryx sp*)- 22,00m<sup>3</sup>
- **Ipê** (*Tabebuia sp*)- 20,00m<sup>3</sup>

### Drying:

KD> Dry in a 16-16 % drying stove

### Weight / KD

- **Cumaru** (*Dipteryx sp*)- 1.250Kg/m<sup>3</sup> [ (+10%) ou (-10%)]
- **Ipê** (*Tabebuia sp*) - 1.300Kg/m<sup>3</sup> [ (+10%) ou (-10%)]

### Milling

· Decking suitable for external use with grooved finish cut on the top and bottom side, and with smooth finish and four round corners of a 3.00-mm radius. S4S e E4E.

### Pallet Stacking

Steel taped. Stacks of specific length and width. Stacked with separators and waxed on top

The natural choice for your home



[www.brasiltropicalpisos.com](http://www.brasiltropicalpisos.com)

Fone/Fax: 55 66 3512 2000 ● [sales@brasiltropicalpisos.com](mailto:sales@brasiltropicalpisos.com)

Sales



Leandro Bianchini Serafin

Alta Floresta ★ Mato Grosso ★ Brasil  
Fone/Fax: + 55 66 3512 2000  
Celular: + 55 66 9996 1659  
Skype: leandroserafin  
M S N : leandroserafin@hotmail.com  
E-mail: leandro@brasiltropicalpisos.com



Roni Santana

1 0 2 - 2 6 8 0 Matheson Blvd.  
Mississauga, ON L4W 0A5 - Canadá  
Phone: 1 9 0 5 2 6 7 3 4 8 3  
Toll free: 1 8 6 6 4 3 1 7 2 5 8  
F a x : 1 9 0 5 2 4 8 3 5 5 1  
E-mail: rsantana@brasiltropicalpisos.com



[www.brasiltropicalpisos.com](http://www.brasiltropicalpisos.com)

Fone/Fax: 55 66 3512 2000 ● [sales@brasiltropicalpisos.com](mailto:sales@brasiltropicalpisos.com)

exotic hardwood  
**DECKING 2011**

*Classic Collection*

